

APPLICATIONS TO REGIONAL TECTONICS

Plate tectonics has taught us to view the Earth's lithosphere as a dynamic system of spreading oceanic ridges, transform faults, and subduction zones. Continental drift is now accepted as a corollary of plate tectonics, and the complexity of orogenic belts is leading to an appreciation of the mobility of continental crust. The margins of continents are often tectonically active, especially above subduction zones. Portions of continental crust can rift from a continent and move, as Baja California is doing today. Continental fore-arc regions may also be displaced during intervals of oblique subduction. Paleomagnetism has played a central role in this developing view of continental geology.

Lithospheric plates carrying continents have experienced intervals of rapid motion, and oceanic plateaus, seamounts, and island arcs have been *accreted* (become attached) to continental margins. Although details are hotly disputed, many geologists now view much of the western Cordillera of North America as a collage of *tectonostratigraphic terranes* (Coney et al., 1980). These terranes are generally fault-bounded regions (dimensions up to hundreds of kilometers) with geologic histories that are distinct from those of neighboring regions. Some terranes are composed of rocks that originated in oceanic basins far from their present locations; others have experienced little or no motion with respect to the continental interior. Paleomagnetism is one of the primary methods of deciphering motion histories of terranes.

This chapter is devoted to applications of paleomagnetism to regional tectonics. We start by introducing general principles and techniques for applying paleomagnetism to regional tectonic problems. Case examples of specific applications are then developed to illustrate how paleomagnetism has been used to decipher continental margin tectonics and motion histories of accreted terranes. The examples are taken from paleomagnetic studies of the western margin of North America, but the principles are generally applicable. Through study of these examples, you will gain insight into the effectiveness and limitations of paleomagnetism in regional tectonics.

SOME GENERAL PRINCIPLES

Throughout this discussion, the term "crustal block" or simply "block" is used to denote a subcontinental-scale region that may have moved with respect to the continental interior. A crustal block may be composed of rocks of continental or oceanic origin. A crustal block may or may not also comprise a tectonostratigraphic terrane that has a specific geologic definition.

The fundamentals of how paleomagnetism can be used to detect motions of crustal blocks are illustrated in Figure 11.1. With paleomagnetism, we can detect only motions with respect to a paleomagnetic pole; purely longitudinal motions cannot be detected because of the geocentric axial dipole nature of the geomagnetic field. In Figure 11.1a, a cross section of the Earth is shown in the plane containing a paleomagnetic pole at location *PP*. The arrows at the Earth's surface show the inclination of the dipolar magnetic field with pole at *PP*; these are the magnetic field *expected inclinations*. If a crustal block is magnetized at intermediate latitude and then moved (angular distance *p*) to high latitude, the *observed inclination* of paleomagnetism in this crustal block will be less than the expected inclination at its new location. So latitudinal motion toward a paleomagnetic pole produces *flattening of inclination* shown by the angle *F* in Figure 11.1a.

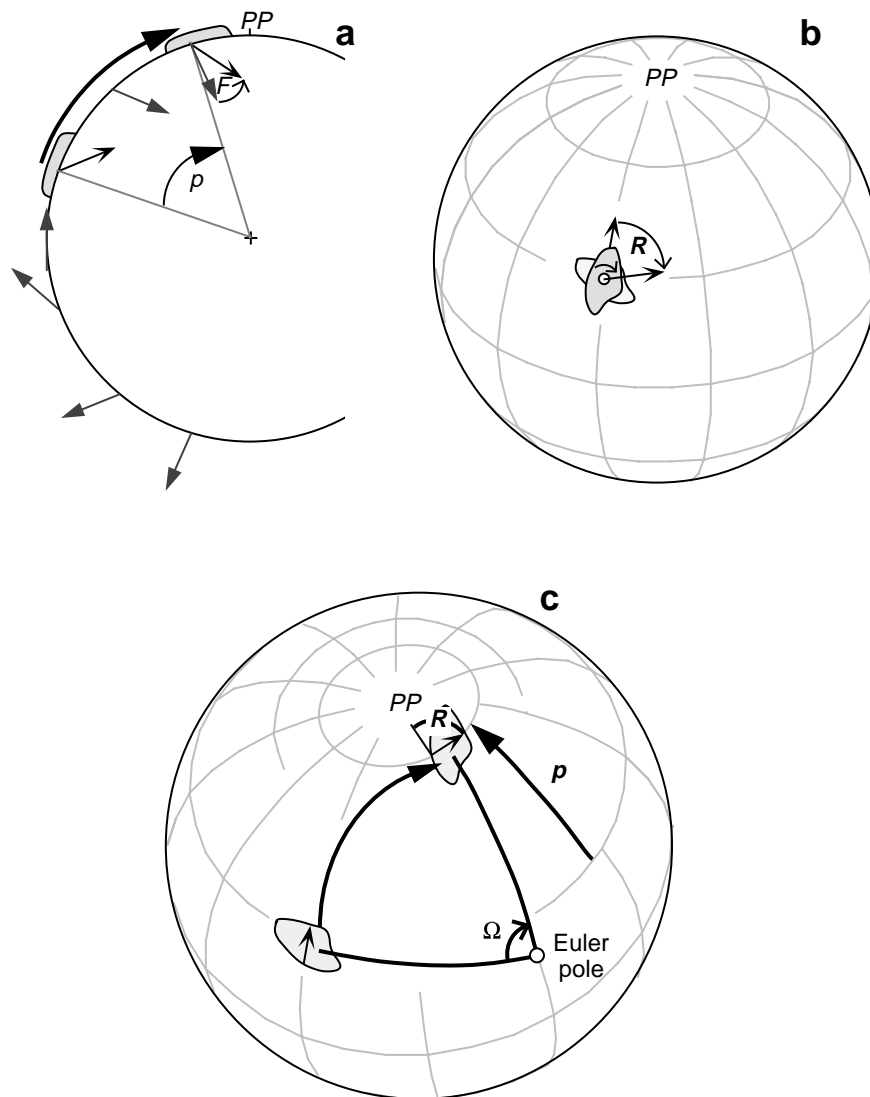

Figure 11.1 Discordant paleomagnetic directions resulting from tectonic movements. *PP* = paleomagnetic pole. **(a)** Meridional cross section of the Earth showing the directions of a dipolar magnetic field with magnetic pole at *PP*; the expected magnetic field directions are shown by the stippled arrows; a terrane magnetized at low paleolatitude acquires a magnetization in the direction of the black arrow; transport of the terrane toward the paleomagnetic pole by the angle *p* results in its magnetization being shallower than the expected direction by the angle *F* (flattening); note that the angle of flattening *F* does not equal the angle of poleward transport *p*. **(b)** Rotation of the paleomagnetic declination by tectonic rotation about a vertical axis internal to the crustal block. The original orientation of the block is shown by the partially hidden outline; the present orientation is shown by the outline filled with the heavier stippling; the crustal block was magnetized along the paleomeridian in the direction of the partially hidden arrow; vertical-axis rotation has caused the paleomagnetic declination to rotate clockwise by the angle *R* to the direction indicated by the arrow drawn from the center of the block; the projection (for this and all global projections to follow) is orthographic, with the latitude and longitude grid in 30° increments. **(c)** Rotation of a crustal block about an Euler pole external to the block. Rotation by the angle Ω about an external Euler pole results in rotation of the paleomagnetic declination by the angle *R* and a poleward translation by the angle *p*.

In Figure 11.1b, a crustal block rotates about a vertical axis located within its boundary; little or no net latitudinal motion occurs during this vertical-axis rotation. The paleomagnetism of rocks of this crustal block would originally have pointed along the *expected declination* toward the paleomagnetic pole PP . But the vertical-axis rotation produces a *rotation*, R , of the *observed declination* from the expected declination.

Motions of lithospheric plates are described by rotations about an *Euler pole* (Cox and Hart, 1986). The tectonic motion of a crustal block (e.g., far-traveled oceanic plateau) can similarly be described by a rotation about an Euler pole that in general is located outside the boundaries of the block. This is illustrated in Figure 11.1c, in which a crustal block is rotated by the angle Ω about an Euler pole. The rotation transports the block in latitude (angular distance = p) and produces a vertical-axis rotation (angle = R); both a flattening of inclination and a rotation of declination result from this motion.

There are two basic methods of analyzing vertical-axis rotations and latitudinal motions from paleomagnetic directions: the *direction-space* and *pole-space* approaches. These methods have been developed by Beck (1976, 1980), Demarest (1983), and Beck et al. (1986). Derivations of the necessary equations are given in the Appendix. At this point, we are concerned only with developing an intuitive appreciation of the direction-space and pole-space approaches.

For most applications, we want to determine motion of a crustal block with respect to a continental interior. The apparent polar wander (APW) path of the continent indicates how that continent has moved with respect to the rotation axis. The set of paleomagnetic poles that make up the APW path also serve as *reference poles* for determining motions of crustal blocks. Each reference pole was determined by paleomagnetic analysis of rocks of a particular age from the continental interior. So in principle the reference pole can be used to calculate the expected paleomagnetic direction for rocks of that age at any point on the continent. Equations (A.53) through (A.61) in the Appendix are used for this calculation.

The direction-space approach is illustrated in Figure 11.2a and developed in the Appendix (Equations (A.62) to (A.67)). The expected direction (I_x, D_x) is simply compared with the observed paleomagnetic direction (I_o, D_o). The inclination flattening, F , is given by

$$F = I_x - I_o \quad (11.1)$$

and the rotation of declination is given by

$$R = D_o - D_x \quad (11.2)$$

R is defined as positive when D_o is clockwise of D_x . The expected and observed directions both have associated confidence limits, so F and R have 95% confidence limits ΔF and ΔR , respectively. The required equations are derived as Equations (A.66) and (A.67) in the Appendix. Results of direction-space analyses are usually reported by listings of $R \pm \Delta R$ and $F \pm \Delta F$. An observed direction that deviates significantly from the expected direction ($F > \Delta F$ and/or $R > \Delta R$) is a *discordant paleomagnetic direction*. An observed direction that is not statistically distinguishable from the expected direction is a *concordant paleomagnetic direction*.

The pole-space approach is illustrated in Figure 11.2b, and the attendant mathematics are derived as Equations (A.68) to (A.78) in the Appendix. In this approach, the comparison is between the reference pole (RP) of the continent and the *observed pole* (OP) determined from a crustal block located at geographic location S . The pole-space method involves analysis of the spherical triangle with corners at S , OP , and RP (Figure 11.2b). The angular distance from S to OP is p_o , while the angular distance from S to RP is p_r ; comparison of these distances indicates whether the block has moved toward or away from the reference pole. The *poleward transport*, p , is given by

$$p = p_o - p_r \quad (11.3)$$

and p is positive if the block has moved toward the reference pole (as shown in Figure 11.2b). The vertical-axis rotation, R , indicated by deviation of the observed pole from the reference pole is the angle of the spherical triangle at apex S (Equation (A.72)). Confidence limits on the reference and observed poles lead

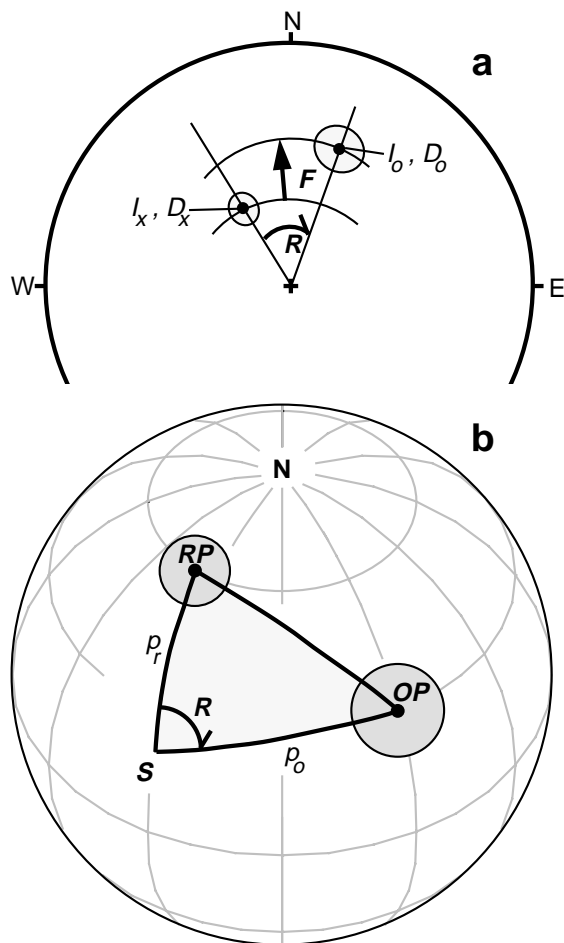

Figure 11.2 Direction-space versus pole-space analysis of paleomagnetic discordance. (a) Equal-area projection of an observed discordant paleomagnetic direction with inclination I_o and declination D_o compared to an expected direction with inclination I_x and declination D_x ; the observed direction is shallower than the expected direction by the flattening angle $F (= I_x - I_o)$; observed declination is clockwise from the expected declination by the rotation angle R . (b) Comparison of observed and reference paleomagnetic poles. The discordant paleomagnetic pole OP (observed pole) was determined from paleomagnetic analysis of rocks at the collection location labeled S ; RP is the reference paleomagnetic pole; the spherical triangle with apices at S , OP , and RP is shown by the heavy lines; p_r = great-circle distance from S to RP ; p_o = great-circle distance from S to OP ; poleward transport $p = p_o - p_r$; vertical-axis rotation R = angle of spherical triangle at S .

to confidence limits Δp and ΔR on p and R , respectively. So results of pole-space analyses are given by $p \pm \Delta p$ and $R \pm \Delta R$, and the observed pole is discordant if statistically significant from the reference pole.

A significant positive flattening of inclination, $F \pm \Delta F$, indicates motion toward the paleomagnetic pole. However, the amount of motion is only indirectly given by the angle F because the inclination is related to paleolatitude through the dipole equation (Equation (1.15)). But a significant positive poleward transport, $p \pm \Delta p$, is a direct measure of motion toward the reference pole. Accordingly, we will use the pole-space approach to determine poleward transport, $p \pm \Delta p$, when analyzing paleolatitudinal motions. For tectonic rotations about a nearby vertical axis, the amount of vertical-axis rotation, $R \pm \Delta R$, can be determined by either the direction-space or pole-space method. Most students find the direction-space approach to vertical-axis rotations intuitively appealing, so that method is used in presenting examples of vertical-axis tectonic rotations. In this way, you will gain experience in both methods.

Before proceeding to the examples, it is important to emphasize the importance of the paleomagnetic data from the crustal block and the importance of the reference pole. All the concerns emphasized in previous chapters about quality and quantity of paleomagnetic data apply to evaluating paleomagnetic data from a crustal block. Important questions include the following:

1. What is the lithology of the rocks sampled, and are those rocks accurate paleomagnetic recorders?
2. Have thorough demagnetization experiments demonstrated isolation of a high-stability characteristic component (ChRM)?
3. What structural corrections are required, and what uncertainties accompany those corrections?
4. What do field tests indicate about the stability and age of the ChRM?
5. Does the set of site-mean directions provide adequate sampling of geomagnetic secular variation?

Your knowledge of rock magnetism and paleomagnetism gained through study of the previous chapters should allow you to effectively address these questions. The quality and quantity of paleomagnetic data used to determine the motion history of a crustal block should be no less than that required for determination of a paleomagnetic pole from the continental interior.

Because all determinations of crustal block motion are with respect to a reference paleomagnetic pole (or expected direction calculated from the reference pole), accuracy of the reference pole is crucial. Inaccuracy in the reference pole leads directly to inaccurate estimates of motion of the crustal block. As discussed earlier in this chapter, development of APW paths (reference poles) for continents is an ongoing process. New data and new methods of analysis sometimes result in significant changes to APW paths. So evaluation of reference poles is equal in importance to evaluation of paleomagnetic data from a crustal block. A case in point is provided by recent analyses of North American Mesozoic APW and resulting implications for motion histories of Cordilleran terranes (Gordon et al., 1984; May and Butler, 1986).

THE TRANSVERSE RANGES, CALIFORNIA: A LARGE, YOUNG ROTATION

The Transverse Ranges of southern California trend east-west, cutting across the dominant northwest-southeast trends of the Coast Ranges and San Andreas fault system (Figure 11.3). Some geological observations suggested that the Transverse Ranges had undergone a major vertical-axis rotation. For example, Jones et al. (1976) noted that structures in Mesozoic rocks of the Transverse Ranges are aligned east-west, whereas similar structures in Mesozoic rocks from Oregon to Baja California are oriented north-south. They concluded that the Transverse Ranges had been affected by a major vertical-axis rotation during the Cretaceous or Tertiary. Paleomagnetism has dramatically confirmed this suggestion, and the magnitude, young age, and rate of rotation are indeed startling. Our first example application of paleomagnetism to regional tectonics is the pioneering work of Kamerling and Luyendyk (1979), who demonstrated major clockwise rotation of the western Transverse Ranges.

The Conejo Volcanics are a sequence of volcanic breccias, tuff breccias, pillow lavas, and massive andesitic and basaltic flows intruded by dikes, sills, and hypabyssal intrusives. These volcanic rocks have

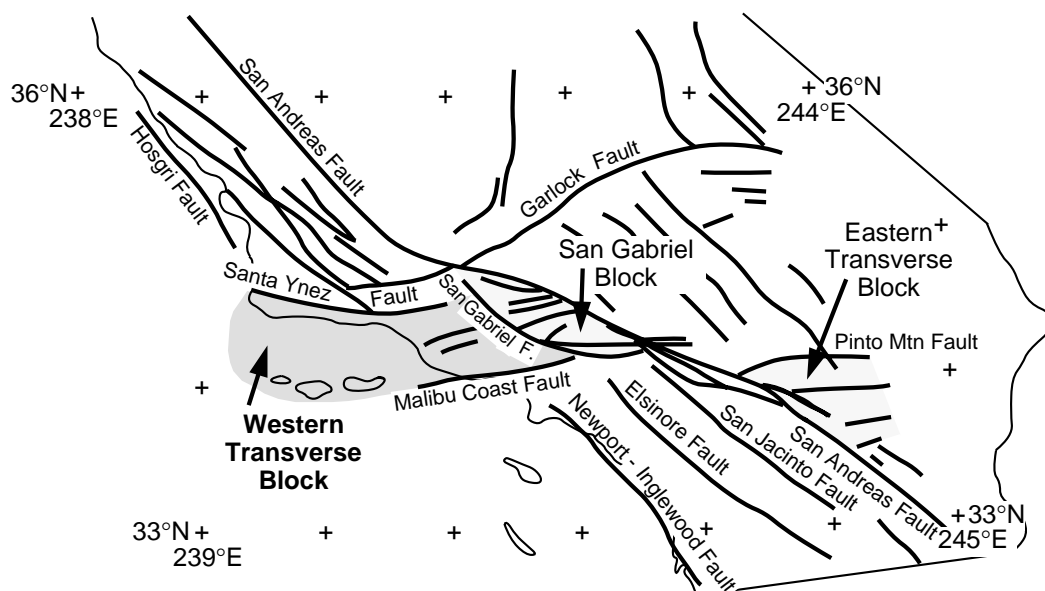

Figure 11.3 Map of southern California. Major Neogene faults are shown by heavy lines; the state boundary of California is shown by the thin line; the Transverse Ranges are shown by the stippled pattern. Redrawn from Luyendyk et al. (1985) with permission from the American Geophysical Union.

been dated by the K-Ar method, and ages range from 13.1 to 16.1 Ma. Kamerling and Luyendyk (1979) collected paleomagnetic samples from the Conejo Volcanics exposed in the Santa Monica Mountains and the Conejo Hills, western Transverse Ranges (mean location approximately 34°N , 241°E).

Five to nine samples were collected from each site (individual flow or dike); secondary components of NRM were generally removed by AF demagnetization to peak fields in the 100- to 600-Oe (10- to 60-mT) range; and the majority of site-mean ChRM directions were determined with $\alpha_{95} < 8^{\circ}$. The 15 site-mean directions from the Conejo Volcanics of the Santa Monica Mountains and Conejo Hills are illustrated in Figure 11.4a. The five normal-polarity sites have mean direction $I = 43.9^{\circ}$, $D = 74.9^{\circ}$, while ten reversed-polarity sites have mean direction $I = -50.1^{\circ}$, $D = 247.1^{\circ}$. These mean directions are not significant from antipodal (5% significance level), so the site-mean ChRM directions pass the reversals test. The dispersion of site-mean ChRM directions suggests that geomagnetic secular variation has been adequately sampled. Available rock-magnetic and paleomagnetic analyses indicate that the Conejo Volcanics provide a reliable paleomagnetic record of the geomagnetic field direction at ~ 15 Ma.

Taking the antipodes of the reversed-polarity site-mean directions and averaging the 15 site-mean directions yields a formation-mean direction $I_o = 47.6^{\circ}$, $D_o = 70.9^{\circ}$, $\alpha_{95} = 7.7^{\circ}$ (Figure 11.4b). The Miocene reference pole for North America is well determined at $\lambda_r = 87.4^{\circ}\text{N}$, $\phi_r = 129.7^{\circ}\text{E}$, $A_{95} = 3.0^{\circ}$ (Hagstrum et al., 1987). Using the site location in the Western Transverse Ranges, Equations (A.53) to (A.61) yield the expected Miocene direction: $I_x = 52.4^{\circ} \pm 3.2^{\circ}$, $D_x = 357.1^{\circ} \pm 3.6^{\circ}$. Comparison of the expected and observed

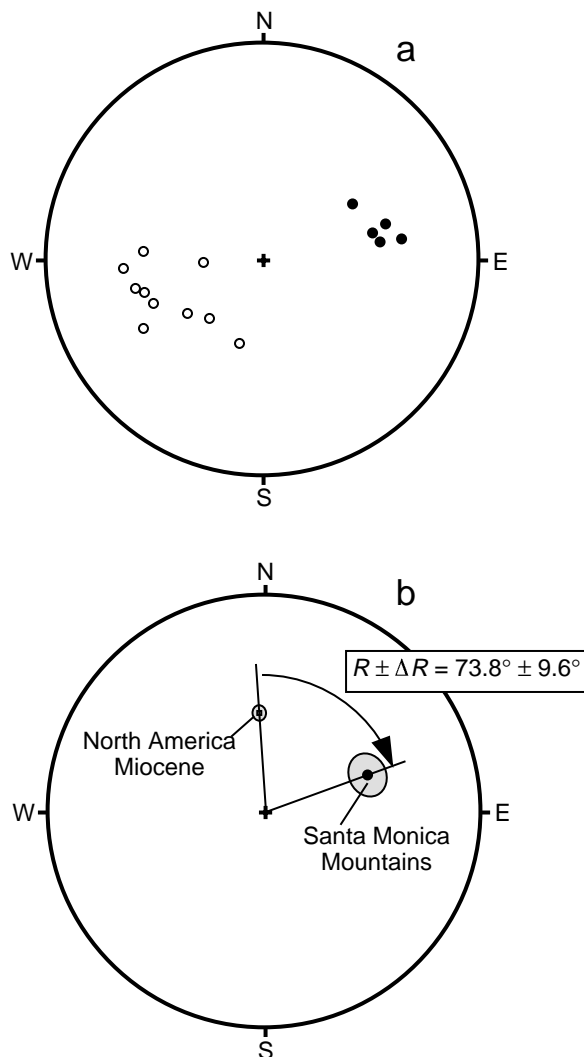

Figure 11.4 (a) Equal-area projection of site-mean ChRM directions from the Conejo Volcanics of the Santa Monica Mountains, western Transverse Ranges. Directions in the lower hemisphere are shown by solid circles; directions in the upper hemisphere are shown by open circles. (b) Comparison of discordant formation-mean ChRM direction from the Conejo Volcanics of the Santa Monica Mountains with the expected direction calculated from the Miocene reference pole for North America. Data from Kamerling and Luyendyk (1979) with permission from the Geological Society of America.

paleomagnetic directions using Equations (A.62) to (A.67) yields $R \pm \Delta R = 73.8^\circ \pm 9.6^\circ$ (Figure 11.4b). Kamerling and Luyendyk (1979) thus quite conclusively demonstrated that the western Transverse Ranges had indeed rotated. The truly surprising result was that $\sim 70^\circ$ of clockwise rotation occurred during the past 15 m.y.

Subsequent paleomagnetic investigations by Bruce Luyendyk and other researchers have extended paleomagnetic sampling to older rocks and other regions of the Transverse Ranges and Mojave Desert. These results were summarized by Luyendyk et al. (1985) and reveal an interesting pattern of post-20-Ma vertical-axis rotations: (1) San Clemente, Santa Barbara, and San Nicolas islands have not rotated, whereas Santa Catalina Island has rotated $\sim 100^\circ$ clockwise; (2) the Northern Channel Islands have rotated clockwise by 70° to 80° ; (3) the Santa Ynez Range has rotated clockwise by $\sim 90^\circ$; and (4) the crustal block between the San Gabriel and San Andreas faults has rotated clockwise $\sim 35^\circ$. The Late Oligocene reconstruction of southern California in Figure 11.5 illustrates the interpretation of this pattern of rotations advanced by Luyendyk et al. (1985). The Transverse Ranges are reconstructed to a north-south orientation and are surrounded by a system of northwest-southeast-oriented right-lateral strike-slip faults. Panels of crust within the Transverse Ranges are separated by left-lateral strike-slip faults, and these panels rotated clockwise as the entire region underwent right shear caused by interaction between the Pacific and North American plates.

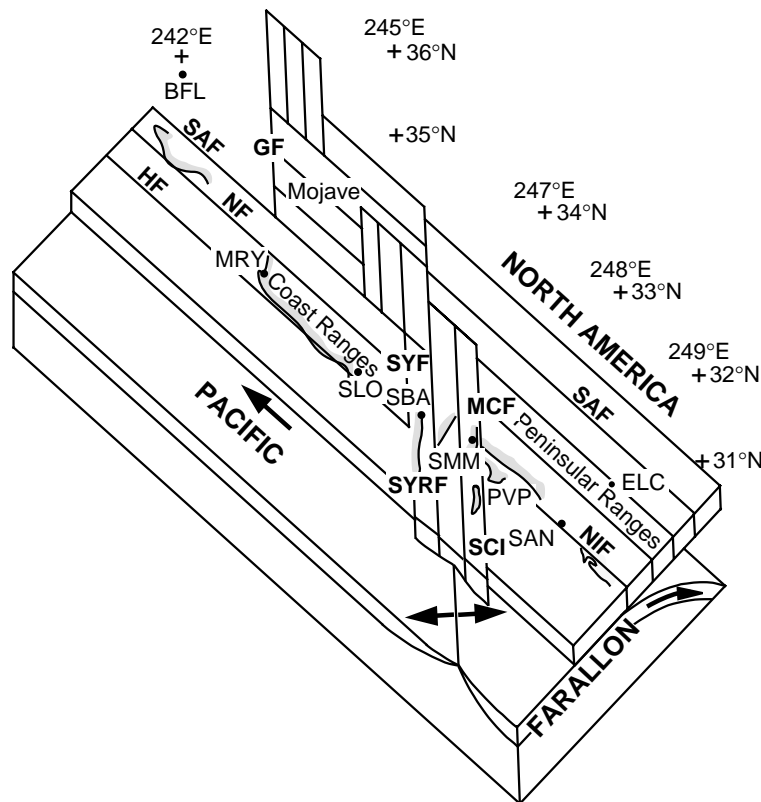

Figure 11.5 Schematic reconstruction of southern California in the Late Oligocene. The Pacific Plate is moving northwest, and the Farallon Plate is subducting beneath the North America plate; separation of the Pacific and Farallon plates at the East Pacific Rise is shown by diverging arrows; crustal panels are separated by strike-slip faults, including SAF = San Andreas fault; NF = Nacimiento fault; HF = Hosgri fault; GF = Garlock fault; SYF = Santa Ynez fault; SYRF = Santa Ynez River fault; MCF = Malibu Coast fault; SCI = Santa Cruz Island fault; NIF = Newport-Inglewood fault; place names are BFL = Bakersfield; MRY = Monterey; SLO = San Luis Obispo; SBA = Santa Barbara; SMM = Santa Monica Mountains; PVP = Palos Verdes Peninsula; SAN = San Diego; ELC = El Centro. Redrawn from Luyendyk et al. (1985) with permission from the American Geophysical Union.

Certainly many questions about the kinematics and dynamics of crustal rotations in southern California remain and will be debated for some time. But paleomagnetic determinations of Neogene rotations have dramatically focused these questions and are a major advance in understanding the tectonic development of this complex region.

THE GOBLE VOLCANICS: AN OLDER, SMALLER ROTATION

Figure 11.6 illustrates the pattern of discordant paleomagnetic declinations observed in the U.S. Pacific Northwest. Cox (1957) observed a paleomagnetic declination in the Eocene Siletz River Volcanics of the Oregon Coast Range that was east of the anticipated direction. But at that time, the expected Eocene direction was poorly known, and the tectonic significance of this early result was not fully appreciated. Subsequently, Simpson and Cox (1977) confirmed that the Oregon Coast Range had rotated clockwise by $\sim 70^\circ$ since the Eocene. In subsequent years, paleomagnetic investigations have determined in considerable

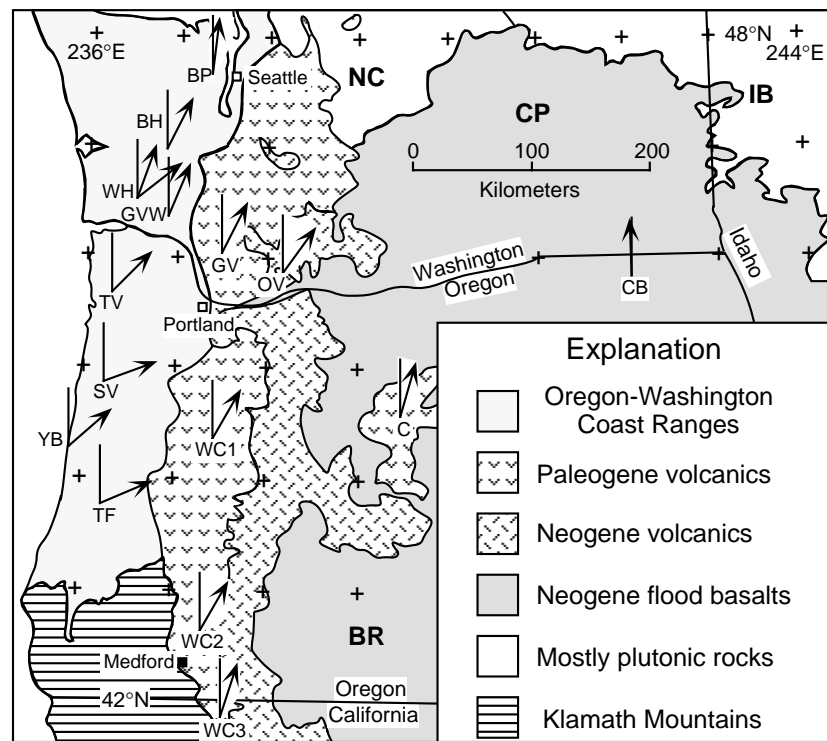

Figure 11.6 Geologic and physiographic provinces of the Pacific Northwest. Expected and observed paleomagnetic declinations are compared at sites of paleomagnetic studies of Cenozoic layered rocks; expected declinations are shown by the north-directed line; observed declinations are shown by arrows; references to paleomagnetic studies are CB = Columbia River Basalt Group (data compiled by Grommé et al., 1986); C = Clarno Formation (Grommé et al., 1986); OV = Ohanapecosh Volcanics (Bates et al., 1981); GV = Goble Volcanics (Beck and Burr, 1979); GVV = Goble Volcanics (Wells and Coe, 1985); WH = Crescent Formation (Wells and Coe, 1985); BH = Crescent Formation (Globerman et al., 1982); BP = Crescent Formation (Beck and Engebretson, 1982); TV = Tillamook Volcanics (Magill et al., 1981); SV = Siletz River Volcanics (Simpson and Cox, 1977); YB = Yachats Basalt (Simpson and Cox, 1977); TF = Tye and Flournoy formations (Simpson and Cox, 1977); WC1&WC2 = Western Cascades Volcanics (Magill and Cox, 1980); WC3 = Western Cascades Volcanics (Beck et al., 1986); geologic/physiographic provinces include NC = North Cascades; IB = Idaho batholith; CP = Columbia Plateau; BR = Basin and Range. Modified from Grommé et al. (1986) with permission from the American Geophysical Union.

detail the spatial and temporal pattern of clockwise rotations in the Pacific Northwest. Attendant tectonic models have become more sophisticated and better constrained as increasing numbers of paleomagnetic results have become available. Recent tectonic syntheses are provided by Wells and Coe (1985), Grommé et al. (1986), and Wells and Heller (1988). Our next example application of paleomagnetism to regional tectonics is the paleomagnetic study by Beck and Burr (1979) of the Goble Volcanics in southwest Washington (labeled GV in Figure 11.6).

The Goble Volcanics consist of subaerial andesitic and basaltic flows with minor pyroclastic and sedimentary deposits, which are part of a volcanic arc ancestral to the present Cascade arc. K-Ar ages range from 32 to 45 Ma (Late Eocene to Early Oligocene). Beck and Burr (1979) reported paleomagnetic results from 392 samples collected from 42 flows. The sampled flows are mostly massive flows 1 m to 30 m thick. Some flows have dips up to 25°, but most dip at less than 10°. Limited sedimentary interbeds and limited outcrops lead to an interesting complication. Are the observed dips due to flows having erupted onto sloping topography and therefore original? Or were the flows originally horizontal with present dips resulting from subsequent tectonic disturbance? The geologic observations do not provide clear evidence as to whether the observed paleomagnetic directions should be structurally corrected for the local dip of the sampled flows. The paleomagnetic data do not solve the problem either. The clustering of site-mean ChRM directions is improved by applying the structural corrections, but the improvement is not statistically significant (k increases from 27.45 to 30.54). Fortunately, the observed dips are generally small, and the sampling region is sufficiently large that observed dips are randomly directed. So no systematic bias is introduced by the structural corrections, and in the final analysis, Beck and Burr (1979) used structurally corrected site-mean directions.

The rock magnetism of the Goble Volcanic Series was fairly straightforward with AF demagnetization successfully isolating the ChRM direction for most flows. Results from four sites were rejected because site-mean ChRM directions had $\alpha_{95} > 15^\circ$. Results from another site were rejected because of its aberrant direction and petrologic character suggesting that it belongs to a younger volcanic series. The resulting 37 site-mean ChRM directions are shown in Figure 11.7a, with reversed-polarity directions inverted through the origin of the equal-area projection.

The 28 normal-polarity sites have mean direction $I = 58.7^\circ$, $D = 19.0^\circ$, $\alpha_{95} = 5.4^\circ$. The mean of the nine reversed-polarity sites ($I = -54.6^\circ$, $D = 197.7^\circ$, $\alpha_{95} = 7.8^\circ$) indicates that the site-mean ChRM directions pass the reversals test. The observed formation-mean direction is $I_o = 57.5^\circ$, $D_o = 18.5^\circ$, $\alpha_{95} = 4.3^\circ$ (Figure 11.7a). An analysis of site-mean VGPs yields an observed pole $\lambda_o = 75.5^\circ\text{N}$, $\phi_o = 345.5^\circ\text{E}$, $A_{95} = 5.5^\circ$, with estimated angular standard deviation ($S = 19.2^\circ$) consistent with adequate sampling of geomagnetic secular variation.

For calculation of the expected direction, we use the mid-Tertiary (20 to 40 Ma) reference pole compiled by Diehl et al. (1988) at $\lambda_r = 81.5^\circ\text{N}$, $\phi_r = 147.3^\circ\text{E}$, $A_{95} = 2.4^\circ$. For the sampling location (46°N , 237.5°E), the resulting expected mid-Tertiary direction is $I_x = 63.7^\circ \pm 1.9^\circ$, $D_x = 347.9^\circ \pm 3.4^\circ$. In Figure 11.7b, this expected mid-Tertiary direction is compared to the observed formation-mean direction from the Goble Volcanic Series. The major result is that the observed declination is clearly discordant, with $R \pm \Delta R = 30.6^\circ \pm 6.9^\circ$. This paleomagnetic study thus provided another important constraint on the spatial and temporal pattern of vertical-axis tectonic rotations in the Pacific Northwest.

An interesting additional observation from the paleomagnetic analysis of the Goble Volcanic Series is that a statistically significant poleward transport is indicated; the direction-space analysis yields $F \pm \Delta F = 6.2^\circ \pm 3.8^\circ$, while the pole-space analysis yields $p \pm \Delta p = 5.3^\circ \pm 4.8^\circ$. We will discuss this result in the Caveats and Summary section.

A further observation illustrated by this example is the limited precision of determining vertical-axis rotations from a formation-mean direction. Fundamentally, because of the dispersion of site-mean directions intrinsic in the required sampling of geomagnetic secular variation, even the best formation-mean direction can rarely be determined with $\alpha_{95} < 5^\circ$. Further considering the confidence limit on the expected direction leads to the conclusion that a formation-mean direction rarely can allow determination of a vertical-axis rotation with confidence limit, ΔR , less than 10° .

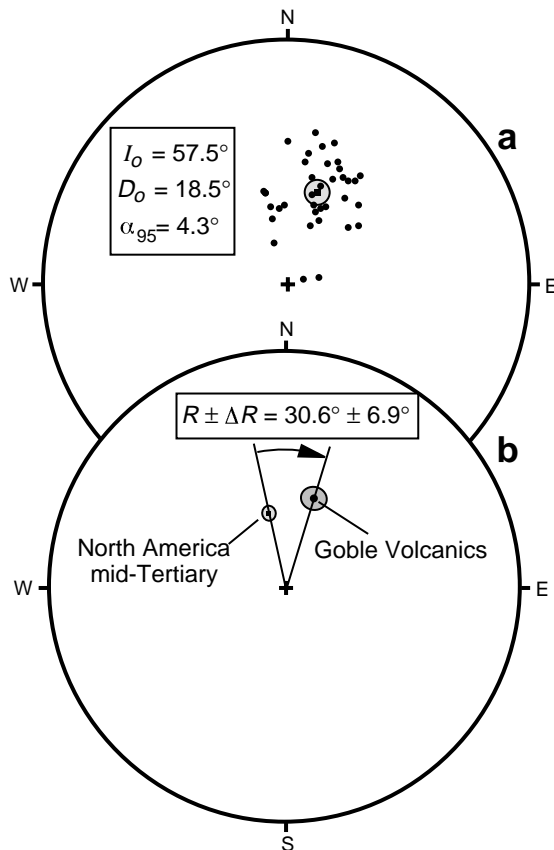

Figure 11.7 (a) Equal-area projection of site-mean ChRM directions from the Goble Volcanic Series of southwest Washington. Directions of reversed-polarity sites have been inverted through the origin of the projection; all directions are in the lower hemisphere; the formation-mean ChRM direction is listed and is shown by the solid square with surrounding stippled α_{95} confidence limit. (b) Comparison of discordant formation-mean ChRM direction from the Goble Volcanic Series with the expected direction calculated from the mid-Tertiary reference pole for North America. Data provided by M. Beck.

Widespread individual flows sometimes serve as accurate recorders of differential vertical-axis rotation across the region that they cover. Magill et al. (1982) reported paleomagnetic results from the Pomona Member of the Saddle Mountains Basalt. This flow erupted at ~12 Ma from a source in western Idaho and flowed >400 km to the Pacific Coast. In the Coast Ranges of southwestern Washington, this flow is also known as the Basalt of Pack Sack Lookout. This “single-flow” method avoids the necessity of averaging geomagnetic secular variation and has allowed resolution of rotations approaching 5° to be determined. Magill et al. (1982) were able to detect a 15° clockwise tectonic rotation of the Coast Range with respect to the Columbia Plateau had occurred since 12 Ma.

Wells and Heller (1988) combined additional results of the single-flow method with an analysis of geologic and paleomagnetic constraints on the rotation history of the Pacific Northwest. They concluded that:

1. The rotation of oceanic microplates during accretion to the continental margin (Figure 11.8a) was not a major mechanism for vertical-axis rotation in the Pacific Northwest.
2. Distribution of right shear between oceanic plates and the North American plate over a 100- to 200-km-wide zone contributes at least 40% of the post-15-Ma rotation of the Coast Ranges. Mechanisms similar to those of Figure 11.8b and 11.8c are involved. The dimensions of the coherently rotating crustal blocks (e.g., balls in the ball-bearing model of Figure 11.8b) are ~20 km (Wells and Coe, 1985).
3. Northwards decreasing amount of extension in the Basin and Range Province east of the Cascade Arc (Figure 11.8d) contributes the remainder (up to 60%) of the post-15-Ma rotation of the Coast Ranges.

It is clear from these examples that paleomagnetism is effective in determining vertical-axis tectonic rotations. This tectonic process is quite difficult to detect by other methods. The growing list of examples indicates that vertical-axis tectonic rotations are a major tectonic process in continental deformation.

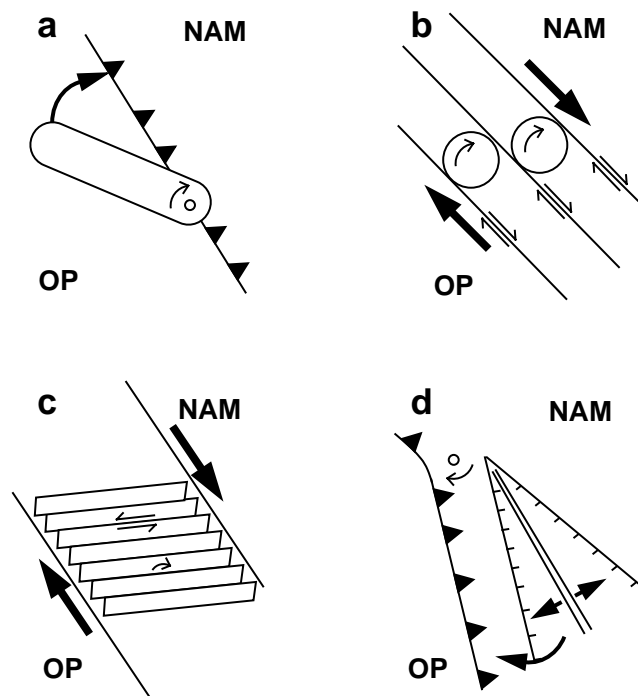

Figure 11.8 Schematic tectonic models for rotation of crustal blocks along the western continental margin of North America. OP = oceanic plate; NAM = North American plate. (a) Rotation during oblique collision; the pivot point is shown by the small circle; barbs are on the overriding plate. (b) Ball-bearing model of right shear distributed between en-echelon right-lateral strike-slip faults. (c) Rotating-panels model of right shear distributed between en-echelon right-lateral strike-slip faults; the small arrow shows clockwise rotation of panels. (d) Rotation by asymmetric extension of the continent inboard of the subduction zone; the zone of extension is shown by diverging arrows; the pivot point is shown by the small circle. Redrawn from Wells and Heller (1988) with permission from the Geological Society of America.

WRANGELLIA IN ALASKA: A FAR-TRAVELED TERRANE

Wrangellia is a tectonostratigraphic terrane exposed along the western Cordillera from eastern Oregon to Alaska (Figure 11.9). Jones et al. (1977) defined Wrangellia to include Late Carboniferous to Early Permian andesitic volcanic arc rocks, Middle to Late Triassic tholeiitic basalt flows and pillow lavas (including the Nikolai Greenstone in Alaska), and Late Triassic platform carbonates. Wrangellia is interpreted to be an ancestral island arc and/or oceanic plateau that was dismembered and dispersed along the North American continental margin. Wrangellia has been the subject of intense paleomagnetic research. Published reports include Hillhouse (1977), Yole and Irving (1980), Hillhouse et al. (1982), Hillhouse and Grommé (1984), and Panuska and Stone (1981, 1985).

To determine motion history in detail, a complete APW path for Wrangellia would be required. But terranes usually represent limited geologic time intervals, and the rocks often are deformed or have suffered chemical or thermal remagnetization. So we rarely have more than one or two paleomagnetic poles from which to decipher the motion history. Our final example application of paleomagnetism to regional tectonics is representative of paleomagnetic studies of displaced terranes. This example is the original paleomagnetic investigation of Wrangellia by Hillhouse (1977).

Paleomagnetism of the Nikolai Greenstone

The Nikolai Greenstone is exposed along the southern flank of the Wrangell Mountains in south-central Alaska (Figure 11.9). This sequence of mostly subaerial tholeiitic basalt flows reaches a stratigraphic thickness of 3000 m. The basalt flows are bracketed by sedimentary rocks containing fossils that indicate a Middle–Late Triassic (Ladinian/Carnian) age for the Nikolai Greenstone. Hillhouse (1977) reported paleomagnetic results from 126 core samples collected at five locations of the Nikolai Greenstone. The samples were collected in 1962, and the collection scheme was somewhat unconventional by present-day standards; just two cores were collected from each individual basalt flow. However, a sufficient number of cores was collected, and stability tests indicate that the resulting data are reliable. Also, subsequent paleomagnetic analysis of nearby portions of Wrangellia have confirmed the original findings.

The rock magnetism of the Nikolai Greenstone was investigated in some detail. Strong-field thermomagnetic experiments revealed Curie temperatures of 570° to 580°C, indicating that Ti-poor titanomagnetite

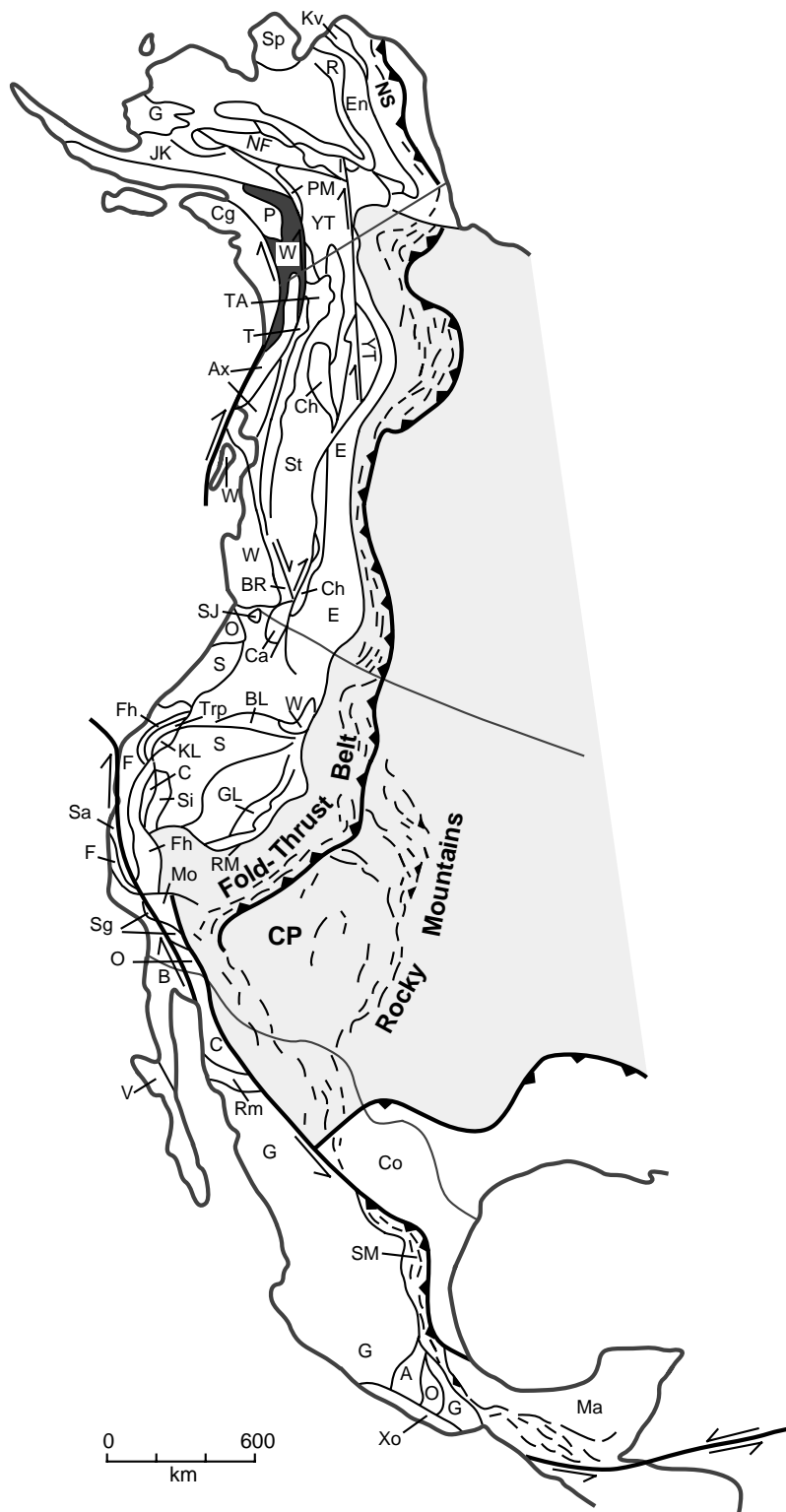

Figure 11.9 Tectonostratigraphic terranes of the North American Cordillera. The area of dark stippling in southern Alaska is the Wrangellia terrane containing the Nikolai Greenstone locality. Definitions and descriptions of terranes can be found in Coney (1981). Redrawn from Coney (1981).

is the dominant ferromagnetic mineral (Chapter 4). Progressive thermal demagnetization experiments indicated two NRM components: a secondary component with blocking temperature (T_B) < 250°C, and a ChRM with T_B in the 505° to 580°C interval. Later work by Hillhouse and Grommé (1984) revealed ChRM blocked above 580°C in samples containing deuteritic hematite. AF demagnetization was used for the majority of samples; demagnetization to peak fields of 400 Oe (40 mT) generally removed a secondary NRM component subparallel to the present geomagnetic field direction. The secondary NRM was interpreted as a VRM, while the ChRM was interpreted as primary TRM.

Because of failure to definitively isolate a ChRM, results from ~30 samples were rejected. At one location, both normal- and reversed-polarity flows were observed in a succession of 27 flows; the ChRM directions from this location passed the reversals test. Changes in bedding attitude between the locations allowed a fold test. In fact, the locality-mean ChRM directions from the Nikolai Greenstone were used in Figure 5.12 to illustrate the fold test. These directions were used again in Chapter 6 as an example of statistical evaluation of the fold test. The ChRM directions pass the fold test (5% significance level), and the structurally corrected locality-mean ChRM directions are shown in Figure 5.12. So the rock-magnetic and paleomagnetic evidence strongly supports the interpretation that the ChRM of the Nikolai basalt flows is a primary TRM.

To determine the paleomagnetic pole for the Nikolai Greenstone, Hillhouse (1977) averaged VGPs from 50 flows. The resulting observed pole ($\lambda_o = 2.2^\circ\text{N}$, $\phi_o = 146.1^\circ\text{E}$, $A_{95} = 4.8^\circ$) is shown in Figure 11.10. An appropriate reference pole for the Late Triassic is the pole from the Chinle Formation (Reeve and Helsley, 1972; Figure 11.10). (The Chinle Formation is younger than the Nikolai Greenstone, but not by an amount that alters the major conclusions.) Using the pole-space method of analysis (Equations (A.68) to (A.78)), the vertical-axis rotation is $R \pm \Delta R = -80.3^\circ \pm 7.8^\circ$. This result indicates that ~80° of counterclockwise vertical-axis rotation accounts for the counterclockwise deflection of the observed pole (Nikolai Greenstone pole) from the reference pole (Chinle pole). But correcting for this vertical-axis rotation does not bring the observed pole into coincidence with the reference pole.

The great-circle distance from the Wrangell Mountains to the reference pole ($p_r = 56.5^\circ$) is less than the distance to the observed pole ($p_o = 79.3^\circ$). The poleward transport of the Nikolai Greenstone is simply the 22.8° difference between p_o and p_r (Equation (11.3)). To produce coincidence of the observed and reference poles, you must move the Nikolai Greenstone (to which the observed pole is attached) southward down the western edge of North America by 22.8°. This result indicates that the Nikolai Greenstone must have been magnetized in the Middle–Late Triassic at a lower paleolatitude than its present location. Between the Middle–Late Triassic and the present, the Nikolai Greenstone was transported toward the Chinle pole (~northward) by 22.8° (~2500 km).

Consideration of the confidence limits on the reference and observed poles leads to $p \pm \Delta p = 22.8^\circ \pm 6.8^\circ$ (Equations (A.76) to (A.78)). The basic conclusion that the Nikolai Greenstone originated far south of its present location seems quite clear. However, $22.8^\circ \pm 6.8^\circ$ is not necessarily the amount of poleward transport experienced by the Nikolai Greenstone. In fact, this is the minimum transport required!

The hemispheric ambiguity

Figure 11.11 illustrates what is referred to as the *hemispheric ambiguity*. The Middle–Late Triassic is a time of frequent geomagnetic polarity reversals (Figure 9.11), and the Nikolai Greenstone contains both normal- and reversed-polarity flows. For Upper Paleozoic or younger rocks of northern North America, we know that rocks of normal polarity have positive inclination and rocks of reversed polarity have negative inclination. But for a far-traveled terrane, this distinction is not clear. As shown in Figure 11.11, a positive inclination results from magnetization in the northern hemisphere during a normal-polarity interval (Figure 11.11a) or from magnetization in the southern hemisphere during a reversed-polarity interval (Figure 11.11b). So it is ambiguous whether flows of the Nikolai Greenstone with positive inclinations are normal-polarity flows magnetized in the northern hemisphere or reversed-polarity flows magnetized in the southern hemisphere.

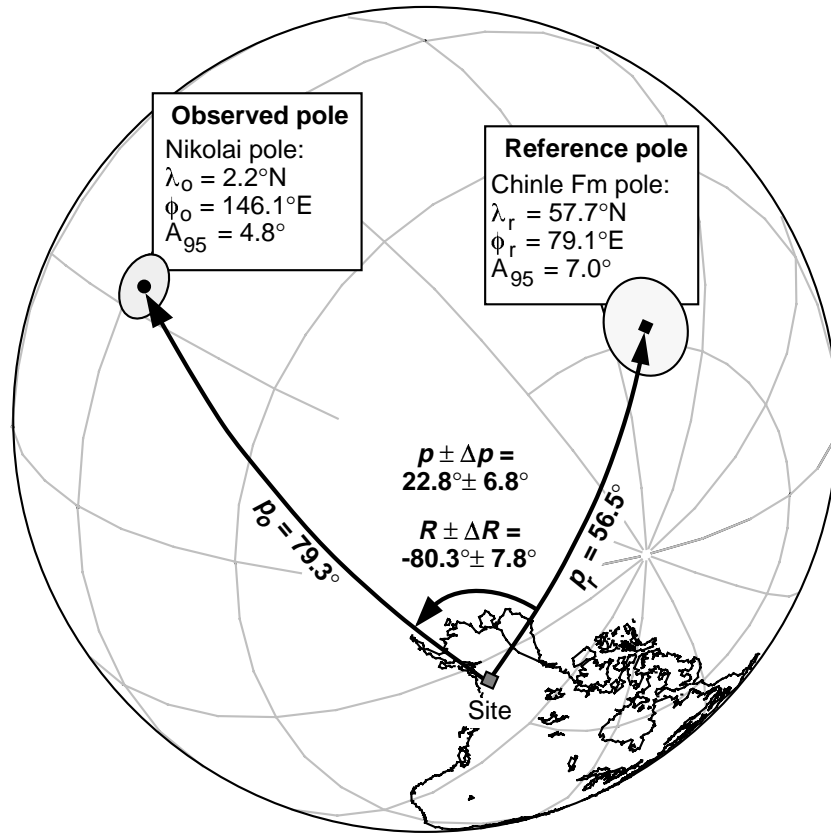

Figure 11.10 Comparison of the paleomagnetic pole from the Middle–Late Triassic Nikolai Greenstone with the reference paleomagnetic pole from the Chinle Formation. The paleomagnetic pole from Nikolai Greenstone is shown by the solid circle; the paleomagnetic pole from the Chinle Formation is shown by the solid square; locations of poles and radii of 95% confidence (A_{95} , shown by the stippled circles) are listed; the collecting site in Alaska is shown by the small stippled square; p_o = great-circle distance from the site to the observed paleomagnetic pole; p_r = great-circle distance from the site to the reference paleomagnetic pole; implied poleward transport, $p \pm \Delta p$, of the Nikolai Greenstone is $p_o - p_r = 22.8^\circ \pm 6.8^\circ$; implied vertical-axis rotation, $R \pm \Delta R$, is counter-clockwise by $80.3^\circ \pm 7.8^\circ$.

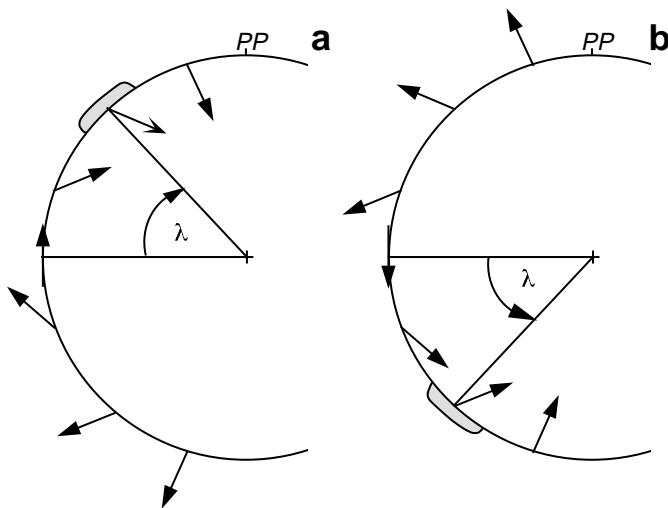

Figure 11.11 The hemispheric ambiguity. Positive inclination of ChRM can indicate either (a) magnetization in the northern hemisphere during a normal-polarity interval or (b) magnetization in the southern hemisphere during a reversed-polarity interval.

The paleogeographic map shown by Hillhouse (1977) places the Nikolai Greenstone in the northern hemisphere. This option requires the minimum poleward transport. Hillhouse (1977) illustrated the northern hemisphere option because of the “principle of least astonishment.” The conclusion of 2500 km of poleward transport of the Nikolai Greenstone is a sufficiently startling result; it is best not to further astonish the reader with the possibility that the Nikolai Greenstone might have originated in the southern hemisphere and been transported >5000 km to its present location. In the specific case of Wrangellia, most researchers have favored a northern hemisphere origin (e.g., Panuska and Stone, 1981).

A Middle–Late Triassic paleogeographic map is shown in Figure 11.12 with North America, South America, and the Nikolai Greenstone placed in their Middle–Late Triassic positions. This map was constructed by using the following steps:

1. North America and South America were placed in their proper relative positions by closing the Atlantic Ocean to reconstruct this portion of Pangea.
2. The pole of the geographic grid was rotated to the reference pole (Chinle pole). This operation produces the Middle–Late Triassic distribution of paleolatitudinal lines across North America and South America. Remember that we have no direct control on paleolongitude, so absolute values of paleolongitude are not known.
3. The great-circle distance from the Nikolai Greenstone to its paleomagnetic pole ($p_o = 79.3^\circ$; Figure 11.10) is its *paleocolatitude*. Through the geocentric dipole hypothesis, this is also the paleolatitudinal distance from the Nikolai Greenstone to the paleogeographic pole. So the paleolatitude of the Nikolai Greenstone is $90^\circ - p_o = 10.7^\circ$. Recalling the hemispheric ambiguity, this paleolatitude could be either 10.7°N or 10.7°S . These paleolatitudes are shown in Figure 11.12. As discussed in the Appendix, the confidence limit on the relative paleolatitudinal position of the Nikolai Greenstone and North America is $\Delta p = 6.8^\circ$, and these limits are shown by the stippled paleolatitude bands in Figure 11.12.

With this paleogeographic map, we get a picture of the minimum distance traveled by the Nikolai Greenstone. We cannot determine the amount of longitudinal motion. Notice that the Middle–Late Triassic paleolatitude of the Wrangell Mountains is 33.5°N ; this is the *expected paleolatitude*. The minimum difference between the expected and observed paleolatitudes is $33.5^\circ\text{N} - 10.7^\circ\text{N} = 22.8^\circ$. This of course is the amount of poleward displacement determined above. The paleomagnetic study of Hillhouse (1977) thus provides a realistic, practical example of how paleomagnetism is used to determine poleward transport of terranes with respect to the continents to which they are now attached.

CAVEATS AND SUMMARY

This discussion of paleomagnetic applications to regional tectonics concludes with a few comments on special problems and concerns. One special consideration is the potential solution of the hemispheric ambiguity provided by polarity superchrons. If rocks of a potentially far-traveled crustal block have ages within a polarity superchron, the polarity of these rocks is known. For example, consider rocks of a particular crustal block with ages within the Cretaceous normal-polarity superchron (~118 to ~83 Ma; Figure 10.11). A formation-mean ChRM direction with positive inclination would indicate a northern hemisphere paleolatitude for these rocks, while a negative inclination would indicate a southern hemisphere origin. The opposite situation holds for the Permo-Carboniferous reversed-polarity superchron, the other well-established polarity superchron during the Phanerozoic.

Resolution of the hemispheric ambiguity for far-traveled crustal blocks by this “superchron method” has proved difficult. Alvarez et al. (1980) and Tarduno et al. (1986) found negative inclinations in the Cretaceous Laytonville Limestone of the Franciscan Complex in northern California. Because the biostratigraphic ages fell within the Cretaceous normal-polarity superchron, these investigators concluded that the Franciscan

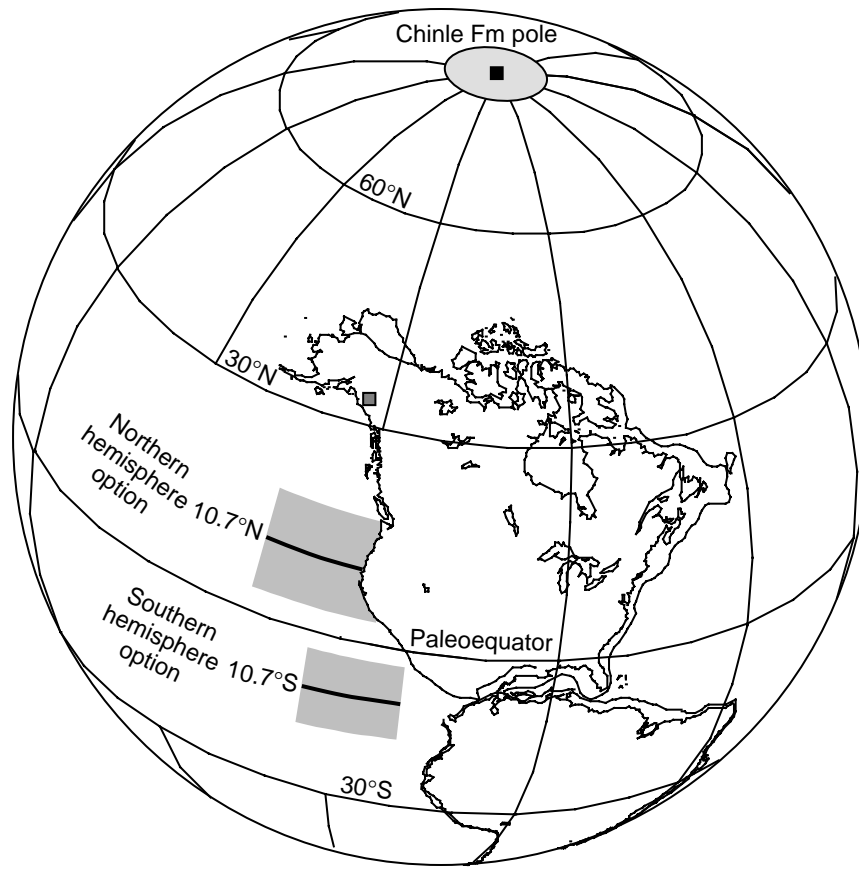

Figure 11.12 Paleogeographic position of the Nikolai Greenstone in the Middle–Late Triassic. The paleomagnetic pole from the Chinle Formation is used as the North American reference pole for the Carnian/Norian stage of the Late Triassic; the Chinle pole is used as the pole of the paleogeographic grid; South America is placed in its Late Triassic paleogeographic position with respect to North America; the Nikolai Greenstone paleolatitude (10.7° north or south) is shown by the heavy line with confidence limits ($\pm 6.8^\circ$) shown by the stipple band of latitudes.

limestones were formed in the southern hemisphere. However, Courtillot et al. (1985) investigated other Franciscan limestones of similar age but different lithology and concluded a northern hemisphere origin. From detailed paleomagnetic analysis of the Laytonville Limestone, Tarduno et al. (1990) have presented a strong case for a southern hemisphere origin of those limestone blocks in the Franciscan mélangé. Apparently, the Franciscan Complex contains some limestone blocks of northern hemisphere origin and other blocks of southern hemisphere origin. The fundamental basis of the superchron method is sound, and it will no doubt be used successfully in the future.

A question that is often asked about tectonic conclusions based on paleomagnetic results concerns the confidence limits ΔR and Δp . What is the real limit on the magnitude of tectonic transport that can be resolved by paleomagnetism? Do the confidence limits ΔR and Δp tell the whole story? If $\Delta p = 5^\circ$ for a particular paleomagnetic study, does this mean that poleward tectonic transport of 550 km is resolvable? In the examples given above, the observed paleomagnetic directions or poles were highly discordant and clearly have important tectonic implications. However, when the rotation of declination (R) or poleward transport (p) just meets or only slightly exceeds the confidence limit, it is not clear what inferences should be drawn. Different methods of data analysis (and even the philosophy of the investigator) can lead to different conclusions.

Let's consider the result from the Goble Volcanic Series discussed above. The clockwise vertical-axis rotation ($R \pm \Delta R = 30.6^\circ \pm 6.9^\circ$) of the sampling region is clearly a statistically significant and geologically

meaningful result. But we also calculated $p \pm \Delta p = 5.3^\circ \pm 4.8^\circ$ for the Goble Volcanic Series. Should we conclude that southwest Washington was transported toward the mid-Tertiary reference pole (~north) by 550 km during the past 30 m.y.? Although I might be unfairly representing the views of some paleomagnetists, I don't think many researchers would use the results of an individual paleomagnetic investigation to conclude a poleward transport of <1000 km (~8°), no matter how solid the data from that investigation might appear. Perhaps if numerous investigations in the same region consistently yield results such as $p \pm \Delta p = 6^\circ \pm 4^\circ$, a conclusion of several hundred kilometers of poleward transport might be justified (Beck, 1984).

The following sage and lucid passage about confidence limits and tectonic displacements (poleward transport) is taken from a discussion of paleomagnetic results from Alaska by Coe et al. (1985):

Three of the displacements appear to be statistically significant at marginally greater than 95% confidence. . . . It is important to note, however, that the formal confidence limits are always minimum estimates for two reasons. First, they are often based on overestimates of the number of independent samplings of the geomagnetic field, especially in the case where a sequence of lava flows is sampled. . . . Second, the formal confidence limits do not take account of possible sources of systematic geological errors. The most serious of these for lava flows is usually uncertainty in the structural correction. For instance, typical initial dips for lava flows on the flanks of shield volcanoes are 5° to 7°, and they may be considerably steeper than this. Such initial dips are difficult to distinguish in ancient environments from tectonic dip and thus undoubtedly lead to spurious estimates of latitudinal displacement. Since 5° error in inclination corresponds to 8° or 9° of apparent latitudinal displacement at the high paleolatitudes of these studies, it is entirely possible that any or all of the paleomagnetically inferred displacements that appear statistically significant (e.g., $-9^\circ \pm 8^\circ$) are artifacts of the initial dip.

Other special considerations that are worthy of mention are discordant paleomagnetic poles observed from plutonic rocks and from magnetite-bearing sedimentary rocks. The special problem with plutonic rocks is that paleohorizontal is not directly known and must be inferred. This ambiguity has led to differing interpretations of discordant paleomagnetic poles observed from Cretaceous plutonic rocks of the North Cascades and British Columbia (Irving et al., 1985; Butler et al. 1989). In Chapter 8, we discussed the possibility of compaction shallowing of paleomagnetic inclinations in magnetite-bearing sedimentary rocks. Paleomagnetically determined paleolatitudes from sedimentary rocks that have suffered inclination shallowing will be biased toward low paleolatitudes. If poleward transport of terranes is determined from rocks with this systematic bias, overestimates of latitudinal transport are likely to result.

REFERENCES

- W. Alvarez, D. V. Kent, I. P. Silva, R. A. Schweickert, and R. A. Larson, Franciscan limestone deposited at 17° south paleolatitude, *Geol. Soc. Am. Bull., Pt. 1*, v. 91, 476–484, 1980.
- R. B. Bates, M. E. Beck, Jr., and R. F. Burmester, Tectonic rotations in the Cascade range of southern Washington, *Geology*, v. 9, 1984–189, 1981.
- M. E. Beck, Jr., Discordant paleomagnetic pole position as evidence of regional shear in the western Cordillera of North America, *Am. J. Sci.*, v. 276, 694–712, 1976.
- M. E. Beck, Jr., Paleomagnetic record of plate-margin tectonic processes along the western edge of North America, *J. Geophys. Res.*, v. 85, 7115–7131, 1980.
- M. E. Beck, Jr., Has the Washington–Oregon Coast Range moved northward?, *Geology*, v. 12, 737–740, 1984.
- M. E. Beck, Jr., and C. D. Burr, Paleomagnetism and tectonic significance of the Goble Volcanic Series, southwestern Washington, *Geology*, v. 7, 175–179, 1979.
- M. E. Beck, Jr., and D. C. Engebretson, Paleomagnetism of small basalt exposures in the west Puget Sound area, Washington, and speculations on the accretionary origin of the Olympic Mountains, *J. Geophys. Res.*, v. 87, 3755–3760, 1982.

- M. E. Beck, Jr., R. F. Burmester, D. E. Craig, C. S. Grommé, and R. E. Wells, Paleomagnetism of middle Tertiary volcanic rocks from the Western Cascade series, northern California: Timing and scale of rotation in the southern Cascades and Klamath Mountains, *J. Geophys. Res.*, v. 91, 8219–8230, 1986.
- R. F. Butler, G. E. Gehrels, W. C. McClelland, S. R. May, and D. Klepacki, Discordant paleomagnetic poles from the Canadian Coast Plutonic Complex: Regional tilt rather than large-scale displacement? *Geology*, v. 17, 691–694, 1989.
- R. S. Coe, B. R. Globerman, P. W. Plumley, and G. A. Thrupp, Paleomagnetic results from Alaska and their tectonic implications, In: *Tectonostratigraphic Terranes of the Circum-Pacific Region*, ed. D. G. Howell, Am. Assoc. Petrol. Geol., Houston Circum-Pacific Council for Energy and Mineral Resources Series, 1, pp. 85–108, 1985.
- P. J. Coney, Accretionary tectonics in western North America, In: *Relations of Tectonics to Ore Deposits in the Southern Cordillera*, ed. W. R. Dickinson and W. D. Payne, *Ariz. Geol. Soc. Digest*, v. XIV, 23–37, 1981.
- P. J. Coney, D. L. Jones, and J. W. H. Monger, Cordilleran suspect terranes, *Nature*, v. 288, 329–333, 1980.
- V. Courtillot, H. Feinberg, J. P. Ragaru, R. Kerguelon, M. McWilliams, and A. Cox, Franciscan Complex limestone deposited at 24°N, *Geology*, v. 13, 107–110, 1985.
- A. V. Cox, Remanent magnetization of lower middle Eocene basalt flows from Oregon, *Nature*, v. 179, 685–686, 1957.
- A. Cox, Frequency of geomagnetic reversals and the symmetry of the nondipole field, *Rev. Geophys.*, v. 13, 35–51, 1975.
- A. V. Cox and R. B. Hart, *Plate Tectonics: How It Works*, Blackwell Scientific Publications, Palo Alto, Calif., 392 pp., 1986.
- H. H. Demarest, Error analysis of the determination of tectonic rotation from paleomagnetic data, *J. Geophys. Res.*, v. 88, 4321–4328, 1983.
- J. Diehl, K. M. McClannahan, and T. J. Bornhorst, Paleomagnetic results from the Mogollon–Datil volcanic field, southwestern New Mexico, and a refined mid-Tertiary reference pole for North America, *J. Geophys. Res.*, v. 93, 4869–4879, 1988.
- B. R. Globerman, M. E. Beck, Jr., and R. A. Duncan, Paleomagnetism and tectonic significance of Eocene basalts from the Black Hills, Washington Coast Range, *Geol. Soc. Am. Bull.*, v. 93, 1151–1159, 1982.
- R. G. Gordon, A. Cox, and S. O'Hare, Paleomagnetic Euler poles and the apparent polar wander and absolute motion of North America since the Carboniferous, *Tectonics*, v. 3, 499–537, 1984.
- C. S. Grommé, M. E. Beck, Jr., R. E. Wells, and D. C. Engebretson, Paleomagnetism of the Tertiary Clarno Hills Formation of central Oregon and its significance for the tectonic history of the Pacific Northwest, *J. Geophys. Res.*, v. 91, 14,089–14,103, 1986.
- J. T. Hagstrum, M. G. Sawlan, B. P. Hausback, J. G. Smith, and C. S. Grommé, Miocene paleomagnetism and tectonic setting of the Baja California Peninsula, Mexico, *J. Geophys. Res.*, v. 92, 2627–2639, 1987.
- J. W. Hillhouse, Paleomagnetism of the Triassic Nikolai Greenstone, McCarthy quadrangle, Alaska, *Can. J. Earth Sci.*, v. 14, 2578–2592, 1977.
- J. W. Hillhouse and C. S. Grommé, Northward displacement and accretion of Wrangellia: New paleomagnetic evidence from Alaska, *J. Geophys. Res.*, v. 89, 4461–4477, 1984.
- J. W. Hillhouse, C. S. Grommé, and T. L. Vallier, Paleomagnetism and Mesozoic tectonics of the Seven Devils volcanic arc in northeastern Oregon, *J. Geophys. Res.*, v. 87, 3777–3794, 1982.
- E. Irving, G. J. Woodsworth, P. J. Wynne, and A. Morrison, Paleomagnetic evidence for displacement from the south of the Coast Plutonic Complex, British Columbia, *Can. J. Earth Sci.*, v. 22, 584–598, 1985.
- D. L. Jones, M. C. Blake, and C. Rangin, The four Jurassic belts of northern California and their significance to the geology of the Southern California borderland, In: *Aspects of the Geologic History of the California Continental Borderland*, ed. D. G. Howell, Misc. Publ. 24, Am. Assoc. Petrol. Geol., Tulsa, Okla., pp. 343–362, 1976.
- D. L. Jones, N. J. Silberling, and J. Hillhouse, Wrangellia—A displaced terrane in northwestern North America, *Can. J. Earth Sci.*, v. 14, 2565–2577, 1977.
- M. J. Kamerling and B. P. Luyendyk, Tectonic rotations of the Santa Monica Mountains region, western Transverse Ranges, California, suggested by paleomagnetic vectors, *Geol. Soc. Am. Bull.*, v. 90, 331–337, 1979.
- B. P. Luyendyk, M. J. Kamerling, R. R. Terres, and J. S. Hornafius, Simple shear of southern California during Neogene time suggested by paleomagnetic declinations, *J. Geophys. Res.*, v. 90, 12,454–12,466, 1985.

- J. R. Magill and A. Cox, Tectonic rotation of the Oregon Western Cascades, Special Paper 10, Oregon Dept. Geol. Min. Ind., Portland, 67 pp., 1980.
- J. R. Magill, A. Cox, and R. Duncan, Tillamook volcanic series: Further evidence for tectonic rotation of the Oregon Coast Range, *J. Geophys. Res.*, v. 86, 2953–2970, 1981.
- J. R. Magill, R. E. Wells, R. W. Simpson, and A. V. Cox, Post-12 m.y. rotation of southwest Washington, *J. Geophys. Res.*, v. 87, 3761–3776, 1982.
- S. R. May and R. F. Butler, North American Jurassic Apparent polar wander: Implications for plate motions, paleogeography and Cordilleran tectonics, *J. Geophys. Res.*, v. 91, 11,519–11,544, 1986.
- B. C. Panuska and D. B. Stone, Late Paleozoic paleomagnetic data for Wrangellia: Resolution of the polarity ambiguity, *Nature*, v. 293, 561–563, 1981.
- B. C. Panuska and D. B. Stone, Latitudinal motion of the Wrangellia and Alexander terranes and southern Alaska superterrane, In: *Tectonostratigraphic Terranes of the Circum-Pacific Region*, ed. D. G. Howell, Am. Assoc. Petrol Geol., Houston Circum-Pacific Council for Energy and Mineral Resources Series, 1, pp. 579, 1985.
- S. C. Reeve and C. E. Helsley, Magnetic reversal sequence in the upper portion of the Chinle Formation, Montoya, New Mexico, *Geol. Soc. Am. Bull.*, v. 83, 3795–3812, 1972.
- R. W. Simpson and A. Cox, Paleomagnetic evidence for tectonic rotation of the Oregon Coast Range, *Geology*, v. 5, 585–589, 1977.
- J. A. Tarduno, M. McWilliams, W. V. Sliter, H. E. Cook, M. C. Blake, Jr., and I. Premoli-Silva, Southern hemisphere origin of the Cretaceous Laytonville Limestone of California, *Science*, v. 231, 1425–1428, 1986.
- J. A. Tarduno, M. McWilliams, and N. Sleep, Fast instantaneous oceanic plate velocities recorded by the Cretaceous Laytonville Limestone: Paleomagnetic analysis and kinematic implications, *J. Geophys. Res.*, v. 95, 15,503–15,527, 1990.
- R. E. Wells and R. S. Coe, Paleomagnetism and geology of Eocene volcanic rocks of southwest Washington: Implications for mechanisms of rotation, *J. Geophys. Res.*, v. 90, 1925–1947, 1985.
- R. E. Wells and P. L. Heller, The relative contribution of accretion, shear, and extension to Cenozoic tectonic rotation in the Pacific Northwest, *Geol. Soc. Am. Bull.*, v. 100, 325–338, 1988.
- R. W. Yole and E. Irving, Displacement of Vancouver Island: Paleomagnetic evidence from the Karmutsen Formation, *Can. J. Earth Sci.*, v. 17, 1210–1288, 1980.